



鑄造中華精品  
振興民族品牌



零配件手冊  
PARTS BOOK



地址：中国·山东齐河县经济开发区齐众大道88号  
电话：(0086) 534-5690688  
传真：(0086) 534-5690707  
网址：[www.sdmix.cn](http://www.sdmix.cn)  
邮箱：[office@sdmix.cn](mailto:office@sdmix.cn)  
服务热线：400 618 8808



山东米科思机械设备有限公司  
SHANDONG MIX MACHINERY EQUIPMENT CO., LTD.

携手共发展 同筑中国梦

## 企业简介 Enterprise Profile

山东米科思机械设备有限公司成立于 2006 年，是一家集机械设备研发、生产、销售于一体的专业企业。业务范围涉及矿山机械、混凝土机械、路面机械等多个领域。

米科思占地 160 亩，生产车间 60000 余平方米，经过十多年的发展，年产能可达 10 亿元人民币。

技术进步、设备精良成为米科思跨越式发展的助推剂，凭借过硬的质量，一流的服务，米科思成为众多知名工程机械厂家的战略合作伙伴，产品远销美国、俄罗斯、迪拜、土耳其、巴西、越南、泰国等几十个国家和地区。

Shandong Mix Machinery Equipment Co.,Ltd was founded in 2006, which is an enterprise specialized in R&D, production and sales of concrete mixing equipments. Our business scope involves mining machinery, concrete machinery, pavement machinery and other fields.

Our company covers an area of 240000 square meters, the workshop is more than 58000 square meters. After more than 10 years of development, the annual production capacity can reach 200 million USD.

Thanks to the advanced technology and excellent equipment, SDMIX has realized great-leap-forward development. We became a strategic partner of many famous engineering machinery manufacturer relying on excellent quality and first-class service. Our products have been exported to dozens of countries and regions, such as America, Russia, Dubai, Turkey, Brazil, Vietnam and Thailand.



## 易损件位置布局图 Layout Of Wear Plate

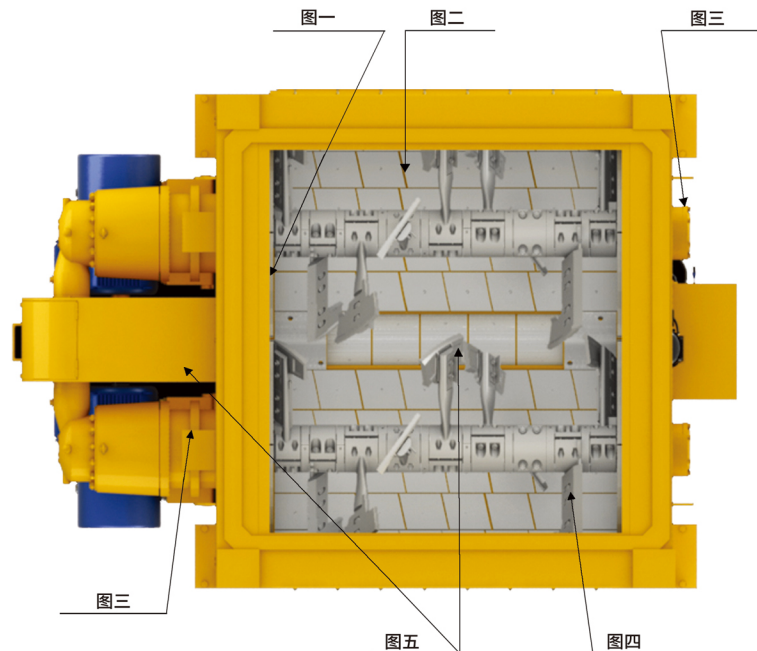

- 图一：侧衬板布局图 Layout Of Wall Linings
- 图二：底板衬板布局图 Layout Of Bottom Linings
- 图三：轴头密封系统布局图 Layout Of Shaft ends sealing system
- 图四：搅拌臂、刮刀布局图 Layout Of Mixing arms & Blades
- 图五：卸料门布局图 Layout Of Discharge door

## 搅拌系统布局图 Layout Of Mixing Arms & Blades

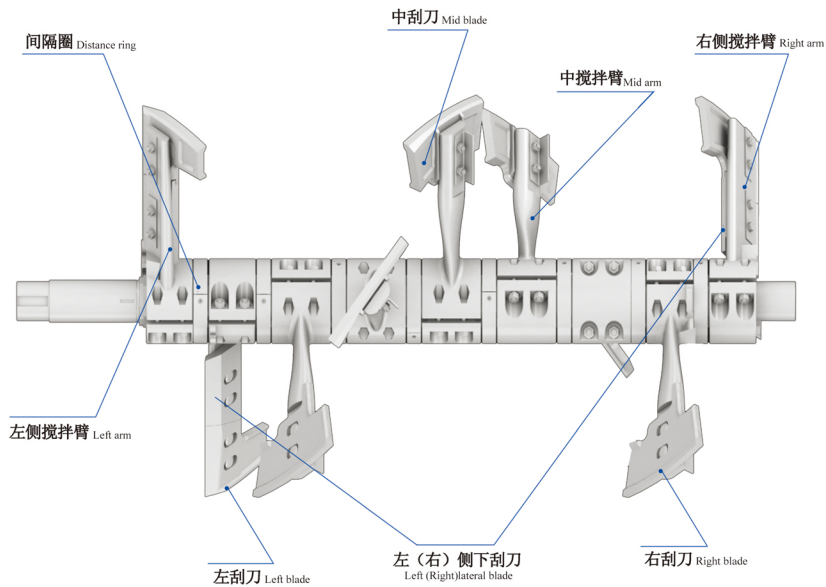

### 备注 (Remarks):

1. 该图为左减速箱端的搅拌臂分布图，右减速箱端的搅拌臂分布图与此图排列相反；  
The picture is layout of the mixing arm for the reducer installed on the left position of mixer,  
The layout of the mixing arm for the reducer installed on the right position of the mixer is totally opposite.

2. 搅拌臂为60°  
The angle of the mixing arm is 60 degree.

3. 1.0/1.25/1.5方搅拌机不区分左右侧下刮刀  
There is no difference of left and right lateral blade for the mixer 1.0/1.25/1.5 cubic meter

## M 搅拌系统配件 Mixing Arms & Blades



### 底衬板布局图

#### Layout Of Bottom Linings

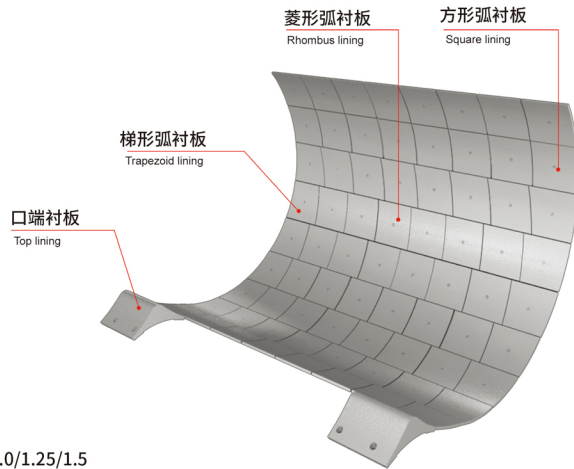

适应机型 1.0/1.25/1.5  
Apply to mixer 2.0/3.0/4.0

#### 技术参数 / Specification

序号 Serial No.	部件名称 Description	1.0方 1.0 Cubic meter	1.25方 1.25 Cubic meter	1.5方 1.5 Cubic meter	2.0方 2.0 Cubic meter	3.0方 3.0 Cubic meter	4.0方 4.0 Cubic meter
1	梯形弧衬板 Trapezoid lining	20	20	20	24	28	28
2	菱形弧衬板 Rhombus lining	40	50	60	72	112	154
3	方形弧衬板 Square lining	24	28	32	32	40	52
4	口端衬板 Top lining			2	2	2	2

### 侧衬板布局图

#### Layout Of Wall Linings

序号	名称	用量
1	侧衬板 wall lining (1)	4
2	侧衬板 wall lining (2)	4
3	侧衬板 wall lining (3)	4
4	侧衬板 wall lining (4)	4
5	侧衬板 wall lining (5)	4
6	侧衬板 wall lining (6)	4

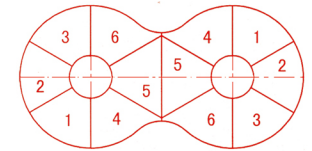

适应机型 Apply to mixer: 1.0/1.25/1.5

序号	名称	用量
1	小半圆侧衬板 (1) Semicircle wall lining	8
2	小半圆侧衬板 (2) Semicircle wall lining	8
3	侧衬板 wall lining (21)	16
4	侧衬板 wall lining (22)	4
5	侧衬板 wall lining (23)	4
6	侧衬板 wall lining (24)	4
7	侧衬板 wall lining (25)	4

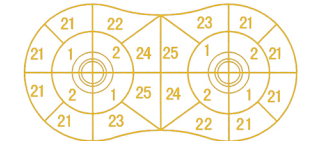

适应机型 Apply to mixer: 2.0/2.5

序号	名称	用量
1	小半圆侧衬板 (1) Semicircle wall lining	8
2	小半圆侧衬板 (2) Semicircle wall lining	8
3	侧衬板 wall lining (31)	8
4	侧衬板 wall lining (32)	8
5	侧衬板 wall lining (33)	4
6	侧衬板 wall lining (34)	4
7	侧衬板 wall lining (35)	4
8	侧衬板 wall lining (36)	4

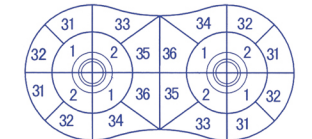

适应机型 Apply to mixer: 3.0/3.5/4.0/4.5

**衬板配件**  
Layout Of Wall Linings

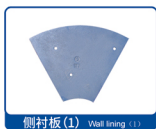

侧衬板(1) Wall lining (1)



侧衬板(2) Wall lining (2)

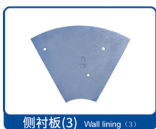

侧衬板(3) Wall lining (3)

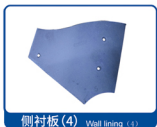

侧衬板(4) Wall lining (4)



侧衬板(5) Wall lining (5)



侧衬板(6) Wall lining (6)

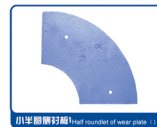

小半圆磨料板 Half round of wear plate

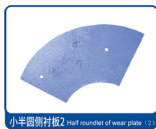

小半圆磨料板2 Half round of wear plate 2

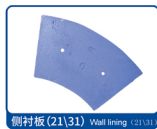

侧衬板(21) Wall lining (21)

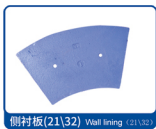

侧衬板(21) Wall lining (21)

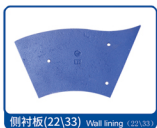

侧衬板(22) Wall lining (22)

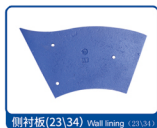

侧衬板(23) Wall lining (23)

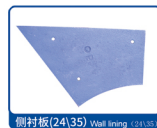

侧衬板(24) Wall lining (24)

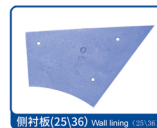

侧衬板(25) Wall lining (25)



梯形衬板 Wear plate (Trapezoid)

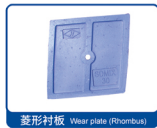

菱形衬板 Wear plate (Rhombus)



方形衬板 Wear plate (Square)

**轴头密封系统布局图**  
Layout Of Shaft Ends Sealing System

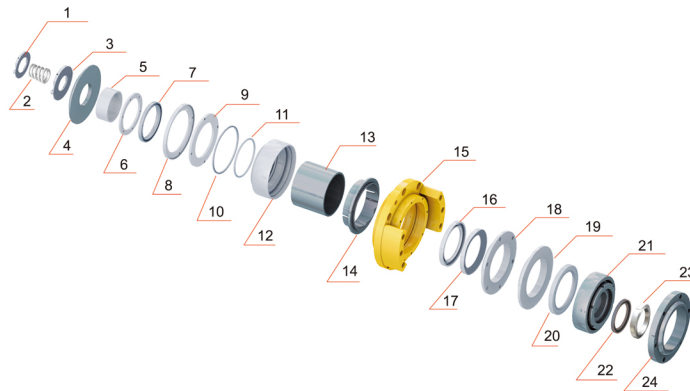

减速箱端图(Gear Box Side)

- |                              |                                       |                              |
|------------------------------|---------------------------------------|------------------------------|
| 1: 挡圈 Detent ring            | 2: 弹簧 Spring                          | 3: 密封圈 B Seal ring B         |
| 4: 密封圈 A Seal ring A         | 5: 钢套 I Bush(1)                       | 6: 压板 clamp                  |
| 7: 防尘圈 Dustproof ring        | 8: 黄胶锁紧钢架 Yellow seal locking support | 9: 黄胶 Yellow seal            |
| 10: 蓝胶 Blue seal             | 11: O型密封圈 O ring                      | 12: 锁轴器主体 Seal mounting ring |
| 13: 钢套 II Bush(2)            | 14: 锁轴器箍圈 Yoke                        | 15: 轴头外壳 Support             |
| 16: 研台密封圈 Grinding seal ring | 17: 骨架油封 Seal(1)                      | 18: 轴头端盖 1 Cover(1)          |
| 19: 轴头端盖 2 Cover(2)          | 20: 骨架油封 2 Seal(2)                    | 21: 轴承 Bearing               |
| 22: 止动垫圈 Stop washer         | 23: 圆螺母 Round nut                     | 24: 轴头端盖 3 Cover(3)          |

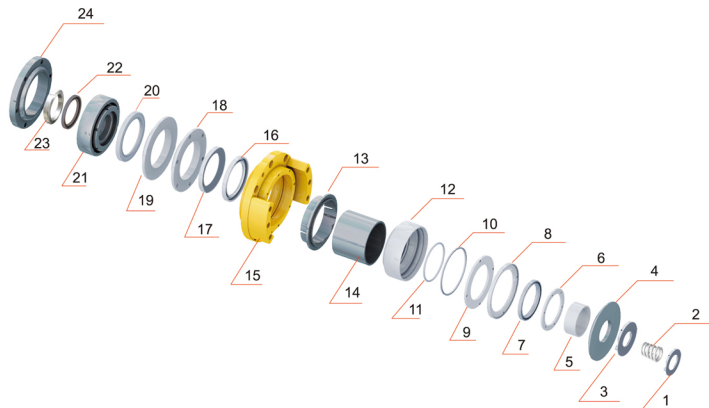

尾端图 (Tail Side)

- |                              |                                       |                              |
|------------------------------|---------------------------------------|------------------------------|
| 1: 挡圈 Detent ring            | 2: 弹簧 Spring                          | 3: 密封圈 B Seal ring B         |
| 4: 密封圈 A Seal ring A         | 5: 钢套 I Bush(1)                       | 6: 压板 clamp                  |
| 7: 防尘圈 Dustproof ring        | 8: 黄胶锁紧钢架 Yellow seal locking support | 9: 黄胶 Yellow seal            |
| 10: 蓝胶 Blue seal             | 11: O型密封圈 O ring                      | 12: 锁轴器主体 Seal mounting ring |
| 13: 锁轴器箍圈 Yoke               | 14: 钢套 II Bush(2)                     | 15: 轴头外壳 Support             |
| 16: 研合密封圈 Grinding seal ring | 17: 骨架油封 Seal(1)                      | 18: 轴头端盖 1 Cover(1)          |
| 19: 轴头端盖 2 Cover(2)          | 20: 骨架油封 2 Seal(2)                    | 21: 轴承 Bearing               |
| 22: 止动垫圈 Stop washer         | 23: 圆螺母 Round nut                     | 24: 轴头端盖 3 Cover(3)          |

轴端密封系统配件  
Spare Parts For Shaft Ends Sealing System

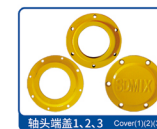
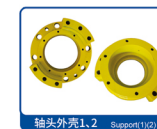
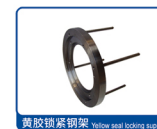
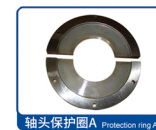
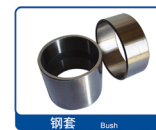
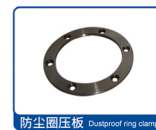
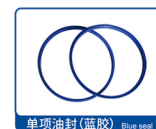
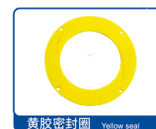
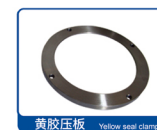
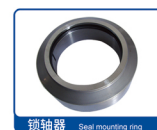

## S 卸料门系统 Spare Parts For Discharge Door

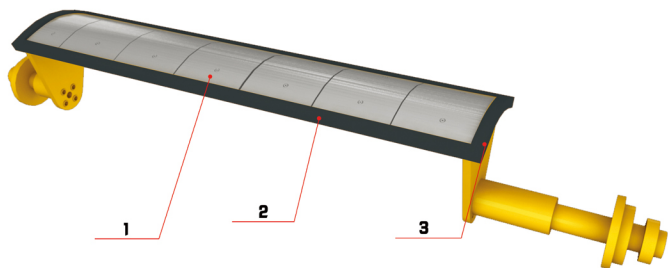

1、卸料门衬板 Discharging door lining  
(适应机型 Apply to mixer: 1.5\2.0\3.0\4.0)



2、卸料门直胶条 Discharging door straight tape  
(适应机型 Apply to mixer: 1.0/1.25/1.5/2.0/3.0/4.0)



3、卸料门圆弧胶条 Discharging door arc tape  
(适应机型 Apply to mixer: 1.0/1.25/1.5/2.0/3.0/4.0)



## S 混凝土搅拌机配件 Spare Parts For Concrete Mixer



黄油嘴 Grease nipple



内丝三通(小) Female tee



油压表 Oil gauge



卸料门油压缸 Hydraulic cylinder



卸料门液油泵 Hydraulic pump



直通快接头 Right angle connector



卸料门电磁阀 Solenoid valve



连接套 Connect set



V型皮带 V belt



润滑油泵 Grease pump



长油嘴 Long grease nipple



电机 Motor

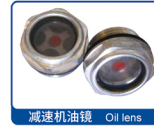

减速机油镜 Oil lens



联轴器 Universal joint



卸料门轴承 Bearing for discharging door

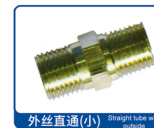

外丝直通(小) Straight tube with nipple



轴承 Bearing



泵芯 Pump core



花键轴/套 Splined shaft/joint



减速机 Gear box

## 售后服务 After Sales Service

完善的售后服务网络，专业的售后服务队伍，让您无后顾之忧！  
Perfect after sale service networks, professional after sale service team, making you carefree.



为各大服务中心 (Service center)  
 为各地办事处 (Branch office)

山东米科思机械设备有限公司在全国建立了以济南、北京、长沙、成都、山西、呼和浩特等城市为服务中心，以各个省级办事处为辐射点的服务网络，形成了覆盖全国的服务保障体系。同时，为了保障用户的利益我公司的配件都是采用合理的价格为供应原则，让用户在购买米科思搅拌机后能够真正的放心使用。

Shandong Mix Machinery Equipment co., Ltd established the service center in Jinan, Changsha, Chengdu, Shanxi, Huhuhaote, and the provincial office service networks all over China, at same time we supply reasonable parts price to our customers, ensuring our customers get the real benefits and carefree.



油压管 Hydraulic pipe



按钮开关 Button switch



活动直角接驳嘴 Flexible right angle connector



上盖安全开关 Cover safety switch



卸料门行程开关 Limit switch for discharge door



卸料门接近开关 Limit switch for discharge door



气动弹簧杆 Pneumatic spring rod



大(小)皮带轮 Belt wheel

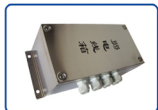

强弱电箱 Strong/weak box



润滑油泵油管 Oil inlet pipe



弯油嘴 Bent oil nipple



搅拌轴 Mixing shaft

## Parts For Screw Conveyor & Concrete Mixing Plant



中吊轴 Middle hoisting bearing



减速机 Gear box



尾轴承 Tail bearing



万向节 Universal ball joint

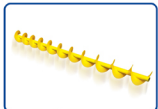

叶片 Flight



蝶阀 Butterfly valve



水阀 Water valve



除尘器 Dust Filter



菊花套 Spline hub set



安全阀 Safe valve



破拱 Aeration pad



料位计 Level Indicator